

Data Sheet



Article number: 20303299

Description: E+G Handwheel
DIN 950-GG-125-K12-A

Measures

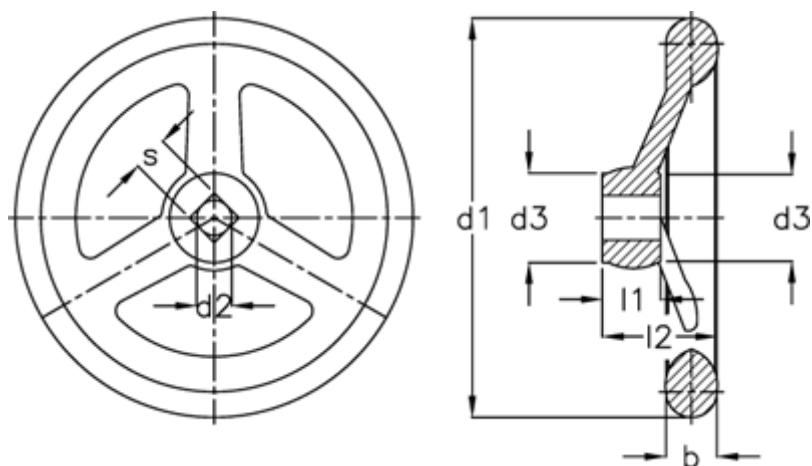

b	= 16
d1	= 125
d2 H7	= 12
d3	= 28
l1	= 18
l2	= 36
Number of spokes	= 3